



Driver LC 200W 24V SC SNC
essence series

Product description

- Constant voltage LED Driver
- Can be either used built-in or independent with clip-on strain-relief (see data sheet chapter: 1. Standards)
- Output voltage 24 V
- Max. output power 200 W
- Dimmable via PWM LED dimmers
- Nominal life-time up to 50,000 h
- 5-year guarantee

Typical application

- Cove lighting, facade accent lighting, ceiling integration

Technical details

- 24 V, 200 W
- Small design (325 x 43 x 30 mm) with stretched-compact strain relief
- Output LF voltage ripple (< 120 Hz) $\pm 1.5\%$
- Push terminal for simple wiring

System solution

- Tridonic LLE-FLEX ADV G2 600, 1,200, 1,800 lm/m
- Tridonic LLE-FLEX EXC 600, 1,200, 1,800, 2,500 lm/m
- In connection with Flex accessories wire to PCB plug



Standards, page 4



System solution



IP20 SELV RoHS

Driver LC 200W 24V SC SNC

essence series

Technical data

Rated supply voltage	220 – 240 V
AC voltage range	198 – 264 V
Mains frequency	50 / 60 Hz
Overvoltage protection	320 V, 1 h
Typ. current (at 230 V, 50 Hz, full load) ^①	940 mA
Max. input power	215 W
Typ. efficiency (at 230 V / 50 Hz / full load)	93 %
λ (at 230 V, 50 Hz, full load) ^①	0,98
Typ. input current in no-load operation	87 mA
Typ. input power in no-load operation	2 W
In-rush current (peak / duration)	125 A / 121 μs
THD (at 230 V, 50 Hz, full load) ^①	< 5 %
Starting time (at 230 V, 50 Hz, full load) ^①	< 0,5 s
Turn off time (at 230 V, 50 Hz, full load)	< 0,5 s
Hold on time at power failure (output)	0 s
Output voltage tolerance	± 1 V
Output LF voltage ripple (< 120 Hz)	± 1,5 %
Max. output voltage (no-load voltage)	25 V
Burst capability	1 kV
Mains surge capability (between L – N)	1 kV
Mains surge capability (between L/N – PE)	2 kV
Life-time	up to 50,000 h
Dimensions L x W x H	325 x 43 x 29,8 mm

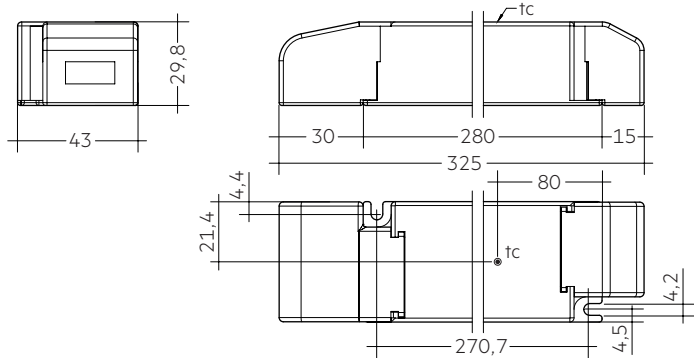

With strain-relief

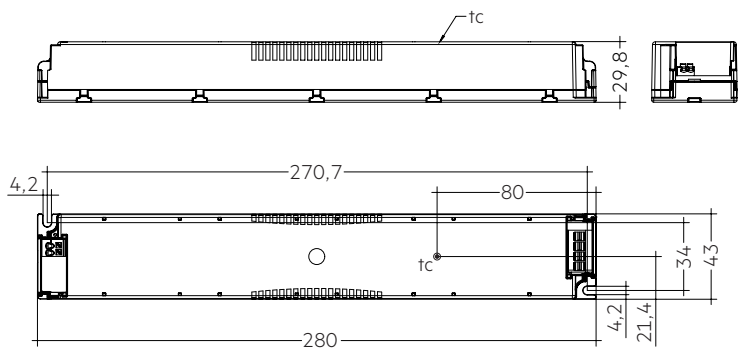

Without strain-relief

Ordering data

Type	Article number	Packaging carton ^②	Packaging, low volume	Packaging, high volume	Weight per pc.
Multi packaging					
LC 200W 24V SC SNC	87500855	10 pc(s).	80 pc(s).	1.040 pc(s).	0.356 kg
Single packaging					
LC 200W 24V SC SNC SP	87500856	20 pc(s).	160 pc(s).	960 pc(s).	0.356 kg

^② The strain relief is included in both packaging variants.
In the single packaging each Driver has also an individual packaging.

Specific technical data

Type	Load	Forward voltage	Output current	Max. output power (at 24 V, full load)	Typ. power consumption (at 24 V, full load)	Typ. current consumption (at 24 V, full load)	Max. casing temperature tc	Ambient temperature ta max.
LC 200W 24V SC SNC	30 %	24 V	2,500 mA	60 W	65,0 W	302 mA	70 °C	-20 ... +50 °C
	40 %	24 V	3,333 mA	80 W	85,6 W	387 mA	70 °C	-20 ... +50 °C
	50 %	24 V	4,167 mA	100 W	107,0 W	477 mA	70 °C	-20 ... +50 °C
	60 %	24 V	5,000 mA	120 W	128,2 W	568 mA	75 °C	-20 ... +50 °C
	70 %	24 V	5,833 mA	140 W	150,0 W	660 mA	75 °C	-20 ... +50 °C
	80 %	24 V	6,667 mA	160 W	171,0 W	750 mA	75 °C	-20 ... +50 °C
	90 %	24 V	7,500 mA	180 W	193,0 W	845 mA	80 °C	-20 ... +50 °C
	100 %	24 V	8,333 mA	200 W	215,0 W	940 mA	80 °C	-20 ... +45 °C

^① Valid at 100 % dimming level.

1. Standards

EN 55015
EN 61000-3-2
EN 61000-3-3
EN 61347-1
EN 61347-2-13
EN 62384
EN 61547

For devices with strain-reliefs the following test marks apply:

 ... Class II luminaires

 ... Independent device

For devices without strain-reliefs the following test mark apply:

 ... Double or reinforced insulation

2. Thermal details and life-time

2.1 Expected life-time

Expected lifetime					
Type	Output load	ta	40 °C	45 °C	50 °C
LC 200W 24V SC SNC	> 180 ... ≤ 200 W	tc	75 °C	80 °C	–
		Life-time	60,000 h	45,000 h	–
	≥ 160 ... ≤ 180 W	tc	70 °C	75 °C	80 °C
		Life-time	100,000 h	75,000 h	55,000 h
	≥ 140 ... < 160 W	tc	70 °C	75 °C	80 °C
		Life-time	>100,000 h	>100,000 h	90,000 h
	< 140 W	tc	70 °C	75 °C	80 °C
		Life-time	>100,000 h	>100,000 h	>100,000 h

The LED control gear is designed for a life-time stated above under reference conditions and with a failure probability of less than 10 %. The relation of tc to ta temperature depends also on the luminaire design. If the measured tc temperature is approx. 5 K below tc max., ta temperature should be checked and eventually critical components (e.g. ELCAP) measured. Detailed information on request.

3. Installation / wiring

3.1 Circuit diagram

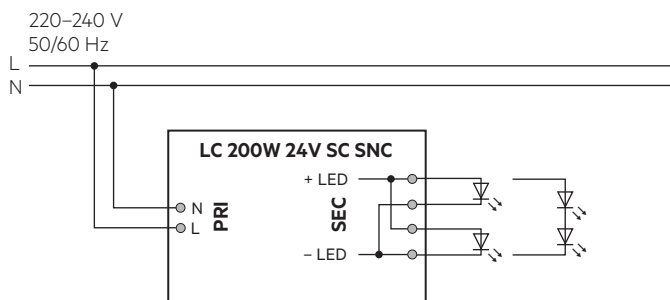

3.2 Wiring type and cross section

The input wiring can be done with a cross section of 0.5 – 1.5 mm². Strip 8.5 – 9.5 mm of insulation from the cables to ensure perfect operation of the push-wire terminals.

The output wiring can be stranded wires with ferrules with a cross section of 0.5 – 1.5 mm² or with solid wires with a cross section of 0.5 – 2.5 mm². Strip 9 – 10 mm of insulation from the cables to ensure perfect operation of the push-wire terminals.

Input wiring

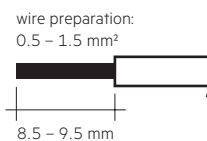

Output wiring

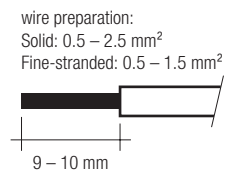

Primary strain relief for cables with bigger cable sheath

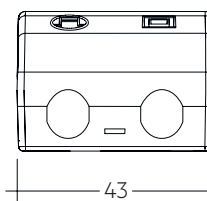

Permissible cable jacket diameter: 2.2 – 9 mm

Secondary strain relief for cable with smaller cable sheath

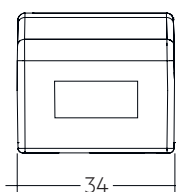

Permissible cable jacket diameter: 3 – 9 mm

3.3 Release of the wiring

Press down the "push button" and remove the cable from front.

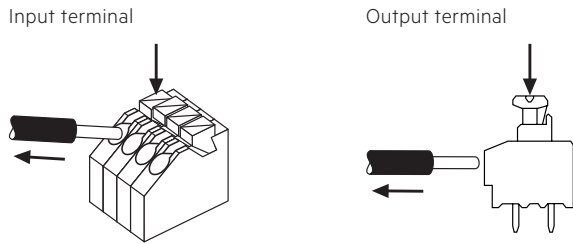

3.4 Fixing conditions when using as independent Driver with Clip-On

Dry, acidfree, oilfree, fatfree. It is not allowed to exceed the maximum ambient temperature (t_a) stated on the device. Minimum distances stated below are recommendations and depend on the actual luminaire. Is not suitable for fixing in corner.

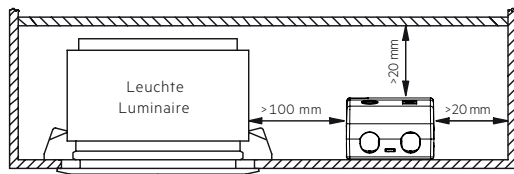

3.5 Wiring guidelines

- The cables should be run separately from the mains connections and mains cables to ensure good EMC conditions.
- The LED wiring should be kept as short as possible to ensure good EMC. The typical secondary cable length is 0.8 m (1.6 m circuit).
- The secondary wires (LED module) should be routed in parallel to ensure good EMC performance.
- The LED Driver has no inverse-polarity protection on the secondary side. Wrong polarity can damage LED modules with no inverse-polarity protection.
- Wrong wiring of the LED Driver can lead to malfunction or irreparable damage.
- To avoid the damage of the Driver, the wiring must be protected against short circuits to earth (sharp edged metal parts, metal cable clips, louver, etc.).

3.6 Installation instructions

The LED module and all contact points within the wiring must be sufficiently insulated against 3 kV surge voltage. Air and creepage distance must be maintained.

4. Electrical values

4.1 Efficiency vs. load

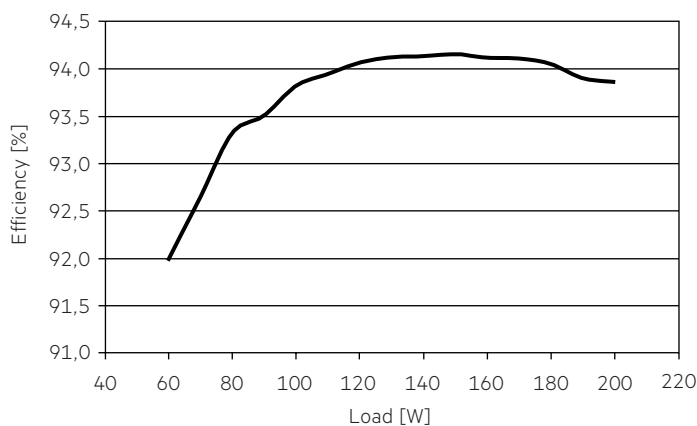

4.2 Power factor vs. Load

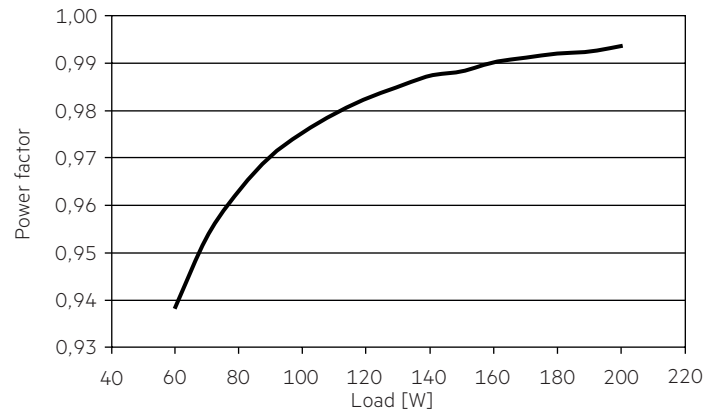

4.3 Input power vs. Load

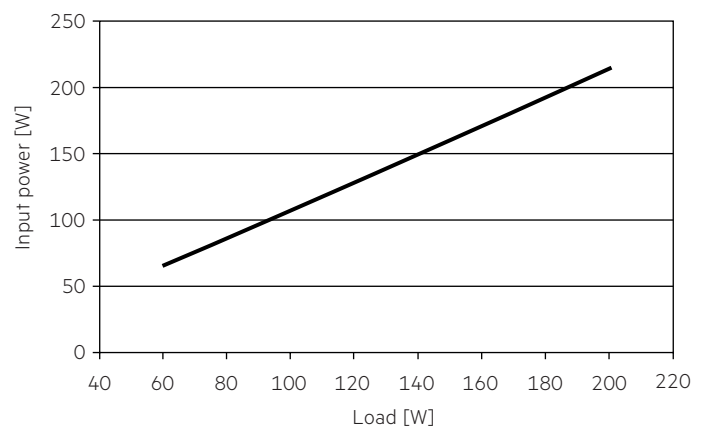

4.4 Input current vs. Load

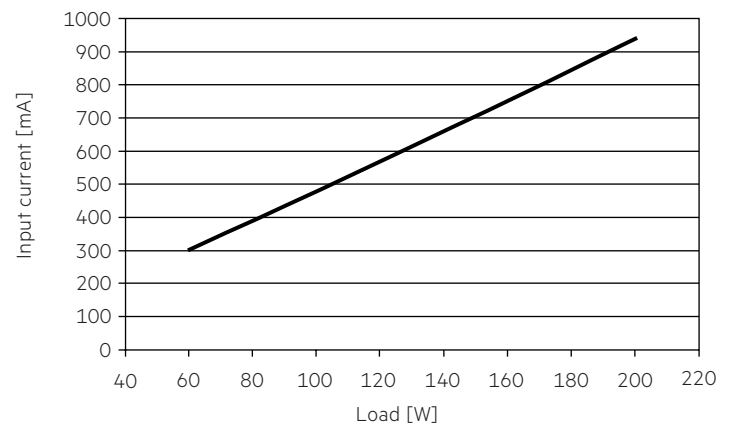

4.5 THD vs. Load

THD without harmonic < 5 mA (0.6 %) of the input current:

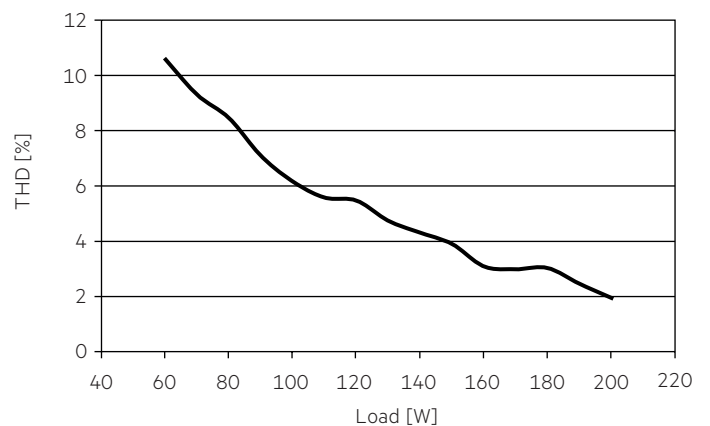

4.6 Maximum loading of automatic circuit breakers

Automatic circuit breaker type	C10	C13	C16	C20	B10	B13	B16	B20	Inrush current	
Installation Ø	1.5 mm ²	1.5 mm ²	1.5 mm ²	2.5 mm ²	1.5 mm ²	1.5 mm ²	1.5 mm ²	2.5 mm ²	I_{max}	time
LC 200W 24V SC SNC	10	13	17	22	6	8	10	13	125 A	121 µs

Typical values for MCB from ABB series S200 as reference.
Actual values can differ due to used MCB types and installation environment.

4.7 Harmonic distortion in the mains supply (at 230 V / 50 Hz and full load) in %

	THD	3.	5.	7.	9.	11.
LC 200W 24V SC SNC	< 5	< 3	< 2	< 2	< 2	< 2

Acc. to 6100-3-2. Harmonics < 5 mA or < 0.6 % (whatever is greater) of the input current are not considered for calculation of THD.

5. Functions

5.1 Overload protection

If the output current range is exceeded, the LED will flicker, and output voltage will be reduced.
When fault is removed, the driver can go back to work automatically without resetting input main power.

5.2 Overtemperature protection

The LED Driver is protected against temporary thermal overheating. If the temperature limit is exceeded the LED will flicker, and restart automatically after the driver cold down. The temperature protection is activated approx. + 15 °C above T_c max.

5.3 Short-circuit behaviour

In case of a short circuit at the LED output the LED output is switched off. When fault is removed, the driver can go back to work automatically without resetting input main power.

5.4 No-load operation

The LED Driver will not be damaged in the no-load operation. When the output is floating and doesn't connect the LED modules, the output voltage will keep the max. voltage (< 25 V). After connecting the LED load, the driver works normally without resetting the main power.

5.5 Hot plug-in

Hot plug-in is supported.
If a LED load is connected, the device does not need to be restarted before the output will be activated again.

6. Miscellaneous

6.1 Isolation and electric strength testing of luminaires

Electronic devices can be damaged by high voltage. This has to be considered during the routine testing of the luminaires in production.

According to IEC 60598-1 Annex Q (informative only!) or ENEC 303-Annex A, each luminaire should be submitted to an isolation test with 500 V_{DC} for 1 second. This test voltage should be connected between the interconnected phase and neutral terminals and the earth terminal.
The isolation resistance must be at least 2MΩ.

As an alternative, IEC 60598-1 Annex Q describes a test of the electrical strength with 1500 V_{AC} (or 1.414 x 1500 V_{DC}). To avoid damage to the electronic devices this test must not be conducted.

6.2 Conditions of use and storage

Humidity: 5% up to max. 85%,
not condensed
(max. 56 days/year at 85%)

Storage temperature: -40 °C up to max. +80 °C

The devices have to be acclimatised to the specified temperature range (t_a) before they can be operated.

6.3 Additional information

Additional technical information at
www.tridonic.com → Technical Data

Guarantee conditions at
www.tridonic.com → Services

Life-time declarations are informative and represent no warranty claim.
No warranty if device was opened.